

TITAN LED120 (Art.-Nr. K226130)

LED Power-Fluter 120W in A4-Chromstahl IP65-IP67
(resistent gegen aggressive Reinigungsmittel und Säuren)



ECOLINE

- Lebensmittel- und Getränke-Industrie
- Chemie- und Pharma-Industrie
- Laboratorien / Universitäten
- urbane Bereiche (Vandalismus)
- zoologische Bereiche



TITAN LED120

LED Power-Fluter 120W für höchste Ansprüche



ANWENDUNG

- Bereich **Stufe 3** (Gefahr von herumfliegenden Teilen und resistent gegen aggressive Reinigungsmittel und Säuren)

BESONDERHEITEN

- A4-Edelstahl Gehäuse aus 1.4404/316L (2mm)
- Frontscheibe: 8mm Polycarbonat kratzfest, >IK10, kein Durchschlag, Splitterfrei, UV-Proof
- Gore-Tex Druckausgleichs-Ventil zur Vermeidung von Kondenswasser
- Keine sich lösenden Bestandteile oder Schrauben
- Resistent gegen aggressive, saure und alkalische Reinigungsmittel
- Anschlusskabel PUR 3x1.5mm oder auf Wunsch PowerFlex Kabel (Ex)

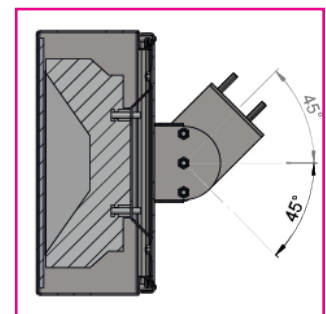

Technische Daten

- Vorschaltgerät: MEANWELL
- Leistungsfaktor: 0.95
- Arbeitstemperatur: -25° ~ +50° C









Optional

- Metallschutzschlauch für Anschlusskabel
- IP67
- Dimmbar DALI
- Dimmbar EnOcean Funk-Connect

Druckausgleichselement Messing mit Membrane



Elbro-No	E-No	W	lm	K		R _a					
K226130	924 500 019	120	14660	5000	120°	>85	A ⁺	✓	IP65	500 x 380 x 200	19.500

weitere Ausführungen auf Anfrage